



Test Report: RST-7K5-230

7.5KW 3 ψ 4W Input With High Voltage Output

■ DESIGN VERIFY TEST

Output Function Test

Input Function Test

Protection Function Test

Control Function Test

Component Stress Test

■ SAFETY & E.M.C. TEST

Safety Test

E.M.C. Test

■ RELIABILITY TEST

ENVIRONMENT TEST

■ DESIGN VERIFY TEST

OUTPUT FUNCTION TEST

NO	TEST ITEM	SPECIFICATION	TEST CONDITION	RESULT
1	OUTPUT VOLTAGE ADJUST RANGE	CH1 : 170 V~ 260 V	I/P : 230 VAC (Δ) O/P : MIN LOAD Ta : 25°C	158.15V~264.85V
2	OUTPUT VOLTAGE(Max) TOLERANCE	V1 : 1%~ -1 %	I/P : 196VAC /305VAC (Δ) O/P : FULL/ MIN. LOAD Ta : 25°C	0.078%~-0.73%
3	LINE REGULATION (Max)	V1 : 0.5%~ -0.5 %	I/P : 230VAC~ 305VAC (Δ) O/P : FULL LOAD Ta : 25°C	V1 : 0%~0%
4	LOAD REGULATION(Max)	V1 : 0.5%~ -0.5 %	I/P : 230VAC (Δ) O/P ; FULL ~MIN LOAD Ta : 25°C	0.30%~-0.394%
5	OVER/UNDERSHOOT TEST	< \pm 10%	I/P : 230VAC (Δ) O/P : FULL LOAD Ta : 25°C	<10%
6	RIPPLE & NOISE(Max)	V1 : 2 Vp-p	I/P : 230VAC (Δ) O/P : FULL LOAD Ta : 25°C	630 mV
<p>high frequency :</p>		<p>low frequency :</p>		
7	SET UP TIME(Max)	230VAC/3000ms	I/P : 230 VAC(Δ) O/P : FULL LOAD Ta : 25°C	1980ms
<p>INPUT=230VAC/50HZ @ FULL LOAD CH1 : Output Voltage CH2 : AC Input Voltage</p>				

8	RISE TIME (Max)	230VAC/200ms	I/P : 230 VAC(Δ) O/P : FULL LOAD Ta : 25°C	48ms
<p>INPUT=230VAC/50HZ @ FULL LOAD</p> <p>CH1 : Output Voltage</p>				
9	HOLD UP TIME (Typ.)	230VAC/10ms at full load 230VAC/16ms at 75% load	I/P : 230 VAC(Δ) O/P : FULL LOAD/75% LOAD Ta : 25°C	230VAC/ 17.8ms / full load 230VAC/ 24.0ms / 75% load
<p>INPUT=230VAC/50HZ @ FULL LOAD</p> <p>CH3 : Output Voltage CH4 : AC Input Voltage</p> <p>INPUT=230VAC/60HZ @ 75% LOAD</p> <p>CH3 : Output Voltage CH4 : AC Input Voltage</p>				
10	DYNAMIC LOAD	V1 : 23Vp-p	I/P : 230VAC(Δ) O/P : (1) FULL /50% LOAD 50%DUTY / 120HZ (2) FULL /50% LOAD 50%DUTY /	(1) 2.81 Vp-p (2) 2.73 Vp-p

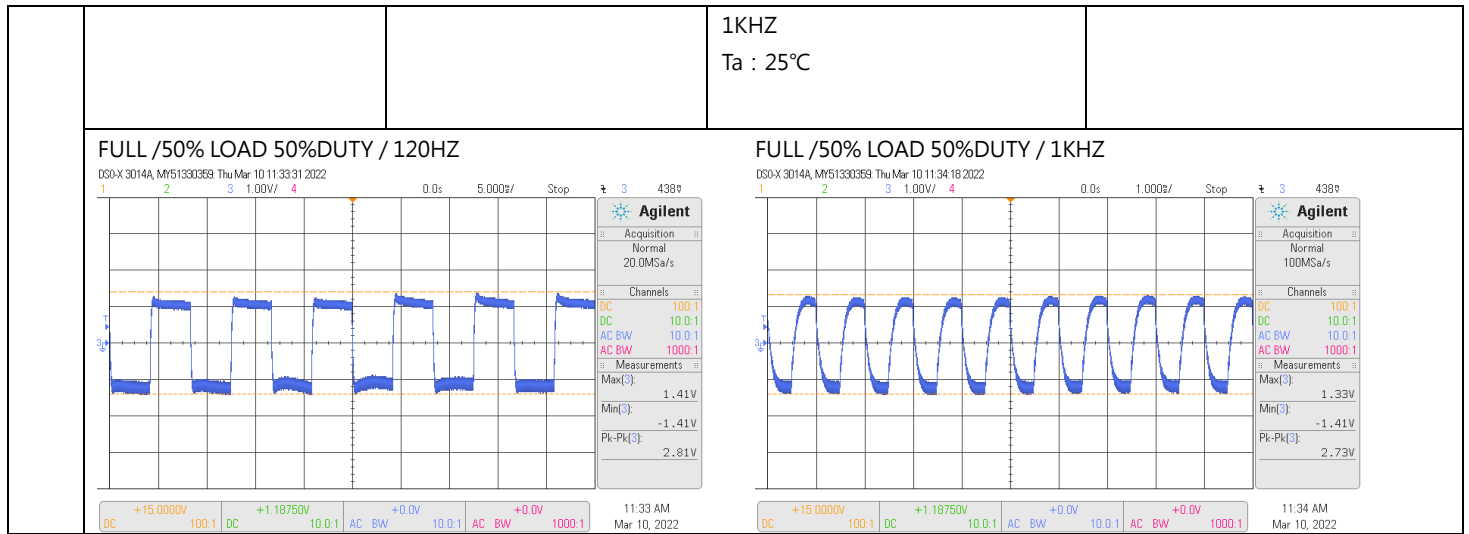

INPUT FUNCTION TEST

NO	TEST ITEM	SPECIFICATION	TEST CONDITION	RESULT
1	INPUT VOLTAGE RANGE	196VAC~305VAC (Δ)	I/P : TESTING O/P : FULL LOAD Ta : 25°C	187.5~305V
			I/P : LOW-LINE 196-3V=193V HIGH-LINE 305+10V=315 V O/P : FULL/MIN LOAD (PLEASE CHECK DERATING CURVE) ON : 30 Sec OFF : 30 Sec 10MIN (POWER ON/OFF NO DAMAGE)	TEST : PASS
2	INPUT FREQUENCY RANGE	47HZ ~63 HZ NO DAMAGE	I/P : 196 VAC ~305VAC (Δ) O/P : FULL~MIN LOAD Ta : 25°C	TEST : PASS
3	INPUT CURRENT (Typ.)	Y : 400V/ 13 A Δ : 230V/22.5A	I/P : 400VAC(Y)/230 VAC (Δ) O/P : FULL LOAD Ta : 25°C	Y : I =11.57A Δ : I=20.2A
4	LEAKAGE CURRENT	< 10mA / 305VAC (Δ) < 3.5mA /530VAC (Y)	I/P : 305VAC (Δ) / 530V (Y) O/P : No LOAD Ta : 25°C	L1-FG : 9.4mA (Δ) / 1mA(Y) L2-FG : 9.4mA (Δ) / 1mA(Y) L3-FG : 9.4mA (Δ) / 1mA(Y)
5	POWER FACTOR (Typ.)	0.98 / 230VAC 0.97/ 277VAC	I/P : 230 VAC/277VAC (Δ) O/P : FULL LOAD Ta : 25°C	PF=0.985/230VAC PF=0.980/277VAC
	P.F vs LOAD			

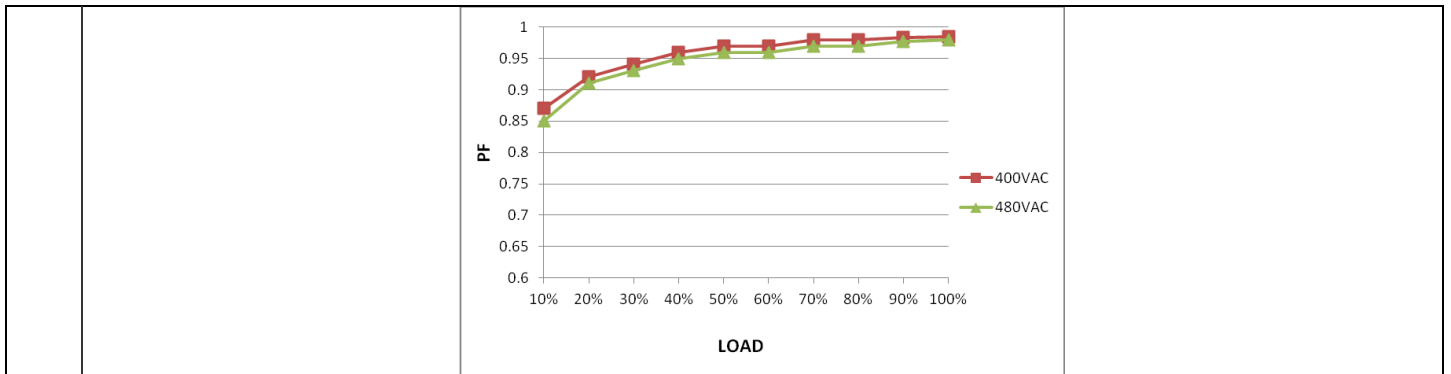

6	EFFICIENCY(Typ.)	95%	I/P : 230 VAC(Δ) O/P : 100% LOAD Ta : 25°C	95.3 %
---	------------------	-----	---	--------

EFFICIENCY vs LOAD

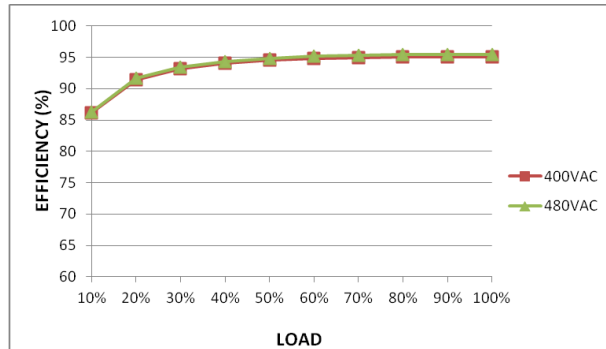

7	INRUSH CURRENT(Typ.)	Y : 400V/50A Δ : 230V/75A COLD START	I/P : 400VAC (Y) I/P : 230 VAC (Δ) O/P : FULL LOAD Ta : 25°C	Y : 32.6 A Δ : 47.4A T50=5.3ms(Δ)
---	----------------------	---	--	---

INPUT=230VAC/50HZ @ FULL LOAD

CH3 : AC Input Voltage CH4 : Input current

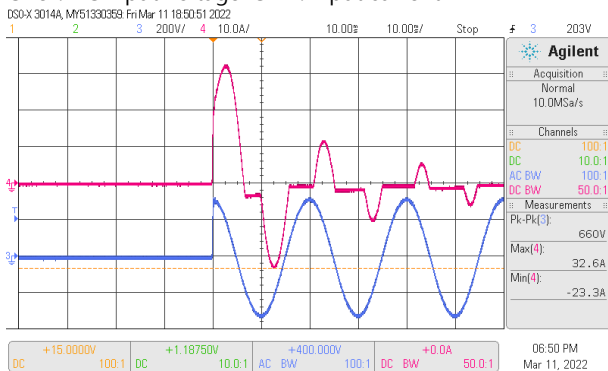

INPUT=230VAC/50HZ @ FULL LOAD

CH3 : AC Input Voltage CH4 : Input current

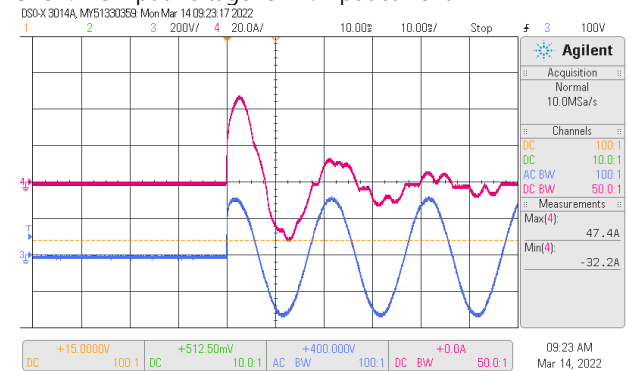

PROTECTION FUNCTION TEST

NO	TEST ITEM	SPECIFICATION	TEST CONDITION	RESULT
1	OVER LOAD PROTECTION	100%~ 107% (196VAC~305VAC) Protection type : Constant current limiting, unit will shutdown after 5 sec. re-power on to recover	I/P : 305VAC(Δ) I/P : 230VAC I/P : 196VAC O/P : TESTING Ta : 25°C O/P: 216V	305V : 104.7 % 230V : 104.7 % 196V : 104.6 % Protection type : Constant current limiting, unit will shutdown after 5 sec. re-power on to recover
2	OVER VOLTAGE PROTECTION	273 V~312 V Protection type : Shut down O/P voltage,re-power on to recover	I/P : 305VAC(Δ) I/P : 230VAC I/P : 196VAC O/P : MIN LOAD Ta : 25°C	I/P 305V : 287V I/P 230V : 287V I/P 196V : 287V Protection type : Shut down O/P voltage,re-power on to recover.
3	OVER TEMPERATURE PROTECTION	Protection type : Shut down O/P voltage, recovers automatically after temperature goes down	I/P : 305VAC(Δ) I/P : 196VAC O/P : FULL LOAD	O.T.P. Active Protection type : Shut down O/P voltage, recovers automatically after temperature goes down
4	SHORT PROTECTION	SHORT EVERY OUTPUT 1 HOUR NO DAMAGE Protection type : Constant current limiting, unit will shutdown after 5 sec. re-power on to recover	I/P : 305VAC(Δ) I/P : 196VAC O/P : FULL LOAD Ta : 25°C	305VAC : PASS 196VAC : PASS Protection type : Constant current limiting, unit will shutdown after 5 sec. re-power on to recover

CONTROL FUNCTION TEST

NO	TEST ITEM	SPECIFICATION	TEST CONDITION	RESULT								
1	AUXILIARY POWER (AUX)	I/P : 230 VAC(Δ) O/P : FULL LOAD Ta : 25°C Test Result : PASS										
		<table border="1"> <thead> <tr> <th>AUX</th> <th>TOLERANCE</th> <th>RIPPLE</th> <th>TEST RESULT</th> </tr> </thead> <tbody> <tr> <td>12V / 0.1A</td> <td>10.8~13.2 V</td> <td>150mVp-p</td> <td>11.861V/103mV</td> </tr> </tbody> </table>			AUX	TOLERANCE	RIPPLE	TEST RESULT	12V / 0.1A	10.8~13.2 V	150mVp-p	11.861V/103mV
AUX	TOLERANCE	RIPPLE	TEST RESULT									
12V / 0.1A	10.8~13.2 V	150mVp-p	11.861V/103mV									
2	REMOTE ON/OFF CONTROL	I/P : 230 VAC(Δ) O/P : FULL LOAD Ta : 25°C Test Result : PASS										
		<table border="1"> <thead> <tr> <th>Between ON/OFF and +12V-AUX</th> <th>Power Supply Status</th> </tr> </thead> <tbody> <tr> <td>SW SHORT(10.8 ~ 13.2V)</td> <td>ON</td> </tr> <tr> <td>SW OPEN(-0.5 ~ 0.5V)</td> <td>OFF</td> </tr> </tbody> </table>			Between ON/OFF and +12V-AUX	Power Supply Status	SW SHORT(10.8 ~ 13.2V)	ON	SW OPEN(-0.5 ~ 0.5V)	OFF		
Between ON/OFF and +12V-AUX	Power Supply Status											
SW SHORT(10.8 ~ 13.2V)	ON											
SW OPEN(-0.5 ~ 0.5V)	OFF											

3 OUTPUT VOLTAGE PROGRAMMABLE(PV)

1.Output Voltage Programming (or, PV / remote voltage programming / remote adjust / margin programming / dynamic voltage trim)
 (1)by potentiometer (SVR)

(a)Have the DIP switch position-3 set as

(b)Output voltage can be trimmed by SVR.

(2)by Output Voltage Programming

(a)Have the DIP switch position-3 set as

(b)The output voltage can be trimmed to 1~120% by applying EXTERNAL VOLTAGE between PV+ and PV-on CN86 or CN87.

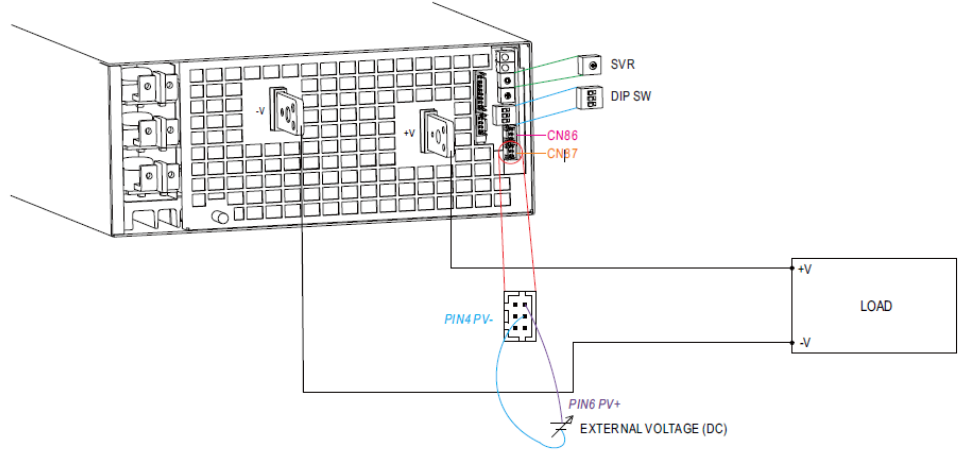
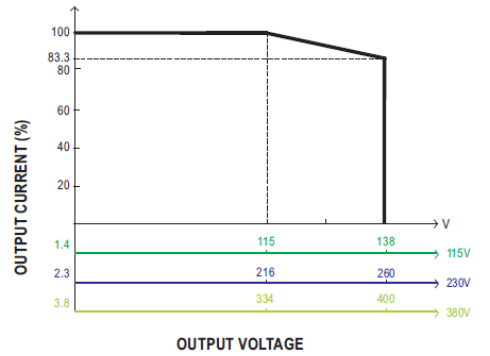
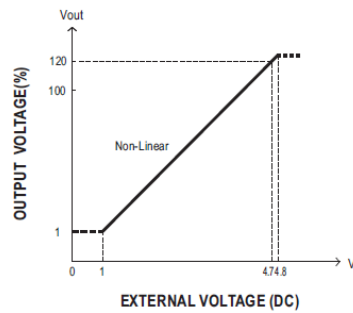

Fig 1.1



© The rated current should change with the Output Voltage Programming accordingly.

I/P : 230 VAC(Δ)

O/P : FULL LOAD

Ta : 25°C

TEST RESULT :

	PV	1V	4.7V
MODEL			
SPEC		2.3V±1.75V	260V±7V
Vout		3.26V	261.25V

4 OUTPUT CURRENT PROGRAMMABLE (PC)

2.Constant Current Programming (or, PC / remote current programming / dynamic current trim)

(1)Default Overload Protection(OLP) 100~105% of rated current

(a)Have the DIP switch position-2 set as 

(b)Output current is set default value.

(2)by Constant Current Level Programming 

(a)Have the DIP switch position-2 set as

(b)The constant current level can be trimmed to 20~100% of the rated current by applying EXTERNAL VOLTAGE between PC+ and PC- on CN86 or CN87.

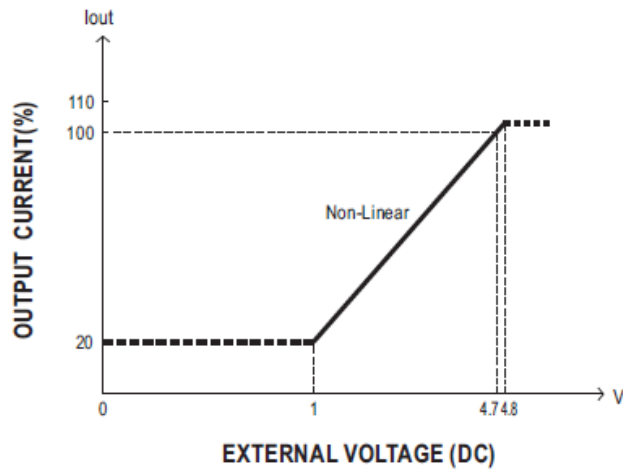
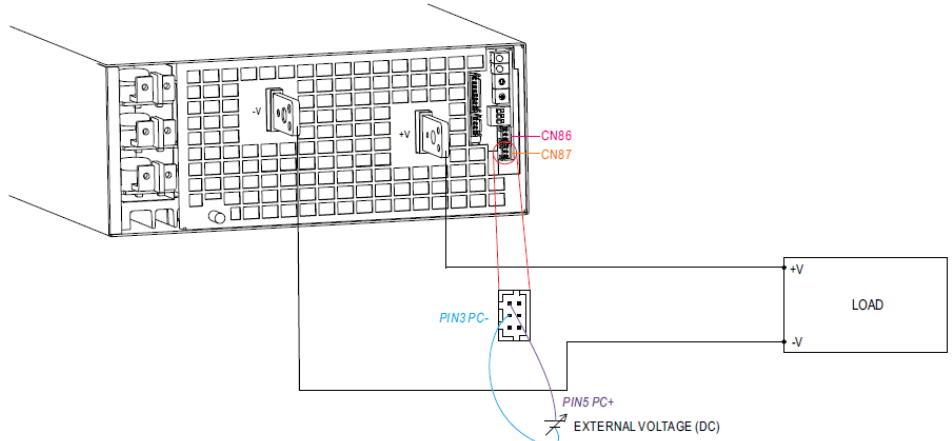

Fig 2.2

Output will shut down after O/P voltage is below < 80% of Vset for 6 sec, re-power on to recover.

I/P : 230 VAC(Δ)

O/P : TESTING

Ta : 25°C

ADJ V	1V	4.7V
SPEC	20%±10%	100%±10%
TEST	21.4%	99.4%

5 Alarm Signal Output

5.1 Alarm Signal Output

※ There are 4 alarm signals on CN99, and each signal can select two types of output circuit.

(1) Relay contact output {OTP1, OTP1-GND} ; {DC-OK1, DC-OK1-GND} ; {AC-FAIL1-GND, AC-FAIL1} ; {FAN-FAIL1-GND, FAN-FAIL1} ;
Normally open contact. "Short" when the alarm arises. Relay contact rating(maximum) is 30V/1A resistive.

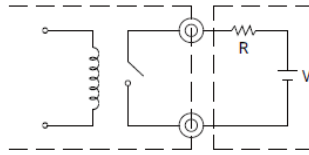

Fig 5.1

Function	Description
DC-OK1	Alarm signal of DC-OK. Normally open contact. "Short" when the PSU turns on. Relay contact rating(maximum) is 30V/1A resistive.
OTP1	Alarm signal of OTP. Normally open contact. "Short" when the PSU over temperature protection occurs. Relay contact rating(maximum) is 30V/1A resistive.
AC_Fail_1	Alarm signal of AC-fail. Normally open contact. "Short" when the PSU input voltage is too low. Relay contact rating(maximum) is 30V/1A resistive.
FAN_Fail_1	Alarm signal of fan fail. Normally open contact. "Short" when the internal fan fails. Relay contact rating(maximum) is 30V/1A resistive.

I/P : 230 VAC(Δ)

O/P : no load/full load

Ta : 25°C

TEST RESULT : PASS

Power Supply Status	DC-OK1 signal	OTP1 signal	AC_Fail_1 signal	FAN_Fail_1 signal
OFF	OPEN	SHORT	SHORT (184VAC)	SHORT
ON	SHORT	OPEN	OPEN (188VAC)	OPEN

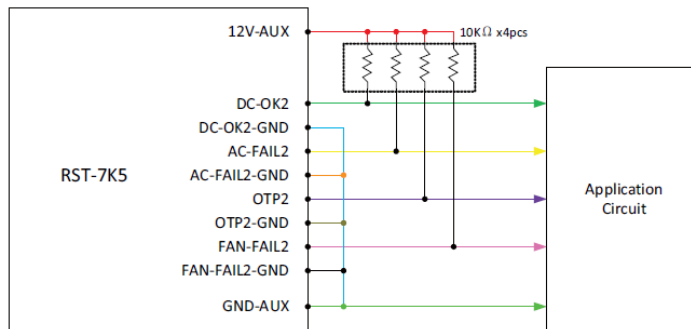

(2) Open collector output {DC-OK2-GND, DC-OK2} ; {AC-FAIL2-GND, AC-FAIL2} ; {OTP2, OTP2-GND} ; {FAN-FAIL2, FAN-FAIL2-GND}

An external voltage source is required for this function that is shown in Fig 5.2. These signals are isolated from output. The maximum sink current is 10mA and the maximum external voltage is 20V (there is a built-in 24V zener diode in inner circuitry).



Function	Description
DC-OK2	Alarm signal of DC-OK. Open collector signal. Low when the PSU turns on. The maximum sink current is 10mA and the maximum external voltage is 20V.
OTP2	Alarm signal of OTP. Open collector signal. Low when the PSU over temperature protection occurs. The maximum sink current is 10mA and the maximum external voltage is 20V.
AC-FAIL2	Alarm signal of AC fail. Open collector signal. Low when the PSU input voltage is too low. The maximum sink current is 10mA and the maximum external voltage is 20V.
FAN-FAIL2	Alarm signal of fan fail. Open collector signal. Low when the internal fan fails. The maximum sink current is 10mA and the maximum external voltage is 20V.

Power Supply	DC-OK1 signal	OTP1 signal	AC_Fail_1 signal	FAN_Fail_1 signal
--------------	---------------	-------------	------------------	-------------------

		Status				
		OFF	HIGH	LOW	LOW (184VAC)	LOW
		ON	LOW	HIGH	HIGH (188VAC)	HIGH
6	Select Overload Protection (OLP) Mode	<p>3. Select Overload Protection (OLP) Mode</p> <p>(1) Continuous Constant Current mode Have the DIPswitch position-1 set as , and RST-7K5 will work in continuous constant current mode when the output is overloaded and the output voltage is greater than 50% of the rated output voltage.</p> <p>(2) Delay Shutdown mode Have the DIPswitch position-1 set as , and RST-7K5 will shut down after 5 seconds of constant current operation, when the output is overloaded or short-circuited.</p> <p>I/P: 230 VAC O/P: 170V Load : CV Mode 170-2V Ta: 25°C Test Result : PASS</p>				
7	CURRENT SHARING	CURRENT SHARING TOLERANCE <±10%	I/P : 230 VAC(Δ) O/P : 100/50% LOAD Ta : 25°C	O/P : 100% PSU1 : 35.35 A PSU2 : 33.81 A PSU3 : 33.12 A PSU4 : 33.56 A O/P : 50% PSU1 : 17.85 A PSU2 : 17.17 A PSU3 : 16.66 A PSU4 : 16.96 A		

COMPONENT STRESS TEST

NO	TEST ITEM	SPECIFICATION	TEST CONDITION	RESULT
1	PWM Transistor (D to S) or (C to E) Peak Voltage	<p>Q333 Rated : 35A/650V VGS : -10V~+22V</p> <p>Q334 Rated : 35A/650V VGS : -10V~+22V</p>	<p>AC ON/OFF</p> <p>I/P : High-Line +3V =308V</p> <p>VDS : VO : 230V</p> <p>O/P : (1) Full Load (2) Output Short (3) Dynamic Load Full Load/ Min. Load 90%Duty/1KHz (4) Dynamic Load Full Load/ Min. Load 90%Duty/3KHz (5) Dynamic Load Full Load/ Min. Load 90%Duty/5KHz (6) Dynamic Load 100% Load/ Min. Load 50%Duty/120Hz (7) 5%→400% Load. Ta : 25°C</p>	<p>Q333 Q334</p> <p>AC=308V AC=308V</p> <p>VO : 230V VO : 230V</p> <p>VDS : VDS :</p> <p>(1) 533V (1) 465V</p> <p>(2) 646V (2) 513V</p> <p>(3) 646V (3) 465V</p> <p>(4) 529V (4) 461V</p> <p>(5) 525V (5) 457V</p> <p>(6) 533V (6) 465V</p> <p>(7) 622V (7) 497V</p>
2	P.F.C Transistor (D to S) or (C to E) Peak Voltage	<p>Q100 Rated : 35A/650V VGS : -8V~+19V</p>	<p>I/P : High-Line +3V =308 V</p> <p>AC ON/OFF</p> <p>O/P :</p>	<p>AC=308V</p> <p>VDS :</p>

			(1)Full Load (2)Output Short (3)Dynamic Load Full Load/ Min. Load 90%Duty/1KHz (4)Dynamic Load Full Load/ Min. Load 90%Duty/3KHz (5)Dynamic Load Full Load/ Min. Load 90%Duty/5KHz (6)Dynamic Load 100% Load/ Min. Load 50%Duty/120Hz (7)5%→400% Load. Ta : 25°C	(1) 585V (2) 585V (3) 569V (4) 565V (5) 561V (6) 513V (7) 433V
3	P.F.C DIODE	D108 Rated 20A/650V TO247	I/P : High-Line +3V =308V AC ON/OFF O/P : (1)Full Load (2)Output Short (3)Dynamic Load Full Load/ Min. Load 90%Duty/5KHz (4)Dynamic Load 100% Load/ Min. Load 50%Duty/120Hz Ta : 25°C	AC=308V (1) 489V (2) 489V (3) 485V (4) 489V
4	Diode Peak Voltage	D711~D716 20A/ 1200V	AC ON/OFF I/P : High-Line +3V =308 V <u>VO : 230V</u> O/P : (1)Full Load (2)Output Short (3)Dynamic Load Full Load/ Min. Load 90%Duty/1KHz (4)Dynamic Load Full Load/ Min. Load 90%Duty/3KHz (5)Dynamic Load Full Load/ Min. Load 90%Duty/5KHz (6)Dynamic Load 100% Load/ Min. Load 50%Duty/120Hz (7)5%→400% Load. (8).NO LOAD Ta : 25°C	D711(D713、D715): <u>VO : 230V</u> (1) 865V (2) 865V (3) 873V (4) 873V (5) 873V (6) 881V (7) 897V (8) 849 V
5	Input Capacitor Voltage	C300~C302 Rated 390u/450V Surge Voltage: 500V	I/P : High-Line +3V =308V O/P : (1)Full Load input on/off (2) Min load input on /Off (3)Full Load /Min load Change (4)Full load continue Ta : 25°C	(1) 441V (2) 441V (3) 450V (4) 441V

6	Control IC Voltage Test	MCU IC(control IC) U901 Rated : 2V~3.6V	AC ON/OFF I/P : High-Line +3V =308 V O/P(1)FULL LOAD (2) Output Short (3)O.L.P (4)O.V.P. (5)NO LOAD VRmin(Low LINE) Ta : 25°C	U901 : (1) 3.296V (2) 3.305V (3) 3.300V (4) 3.305V (5) 3.305V
8	TOP SWITCHING STAND BY POWER	U601 Rated : 4 A/800V	AC ON/OFF <u>VO : 230V</u> I/P : High-Line +3V =308V O/P : (1)Full Load (2)Remote On/Off Ta : 25°C	U601 (1) 634V (2) 634V

SAFETY TEST

NO	TEST ITEM	SPECIFICATION	TEST CONDITION	RESULT
1	WITHSTAND VOLTAGE	I/P-O/P : 4.3KVDC/min I/P-FG : 2.8KVDC/min O/P-FG : 2.8KVDC/min	I/P-O/P : 4.73KVDC/min I/P-FG : 3.36KVDC /min O/P-FG : 3.36KVDC/min Ta : 25°C	I/P-O/P : 2 μ A I/P-FG : 2 μ A O/P-FG : 2 μ A NO DAMAGE
2	ISOLATION RESISTANCE	I/P-O/P : 500VDC>100M Ω I/P-FG : 500VDC>100M Ω O/P-FG : 500VDC>100M Ω	I/P-O/P : 500 VDC I/P-FG : 500 VDC O/P-FG : 500 VDC Ta : 25°C	I/P-O/P : 3.5G Ω I/P-FG : 3.42G Ω O/P-FG : 3.32G Ω NO DAMAGE
3	GROUNDING CONTINUITY	FG(PE) TO CHASSIS OR TRACE < 100 m Ω	40A / 2min Ta : 25°C	26m Ω

E.M.C TEST

NO	TEST ITEM	SPECIFICATION	TEST CONDITION	RESULT
1	HARMONIC	BS EN61000-3-2	I/P : 230VAC/50HZ O/P : FULL LOAD Ta : 25°C	PASS
2	CONDUCTED	BS EN55032(CISPR32) / BS EN/EN55011(CISPR11) CLASS B	I/P : 230 VAC (50HZ) O/P : FULL/50% LOAD Ta : 25°C	PASS
3	RADIATION	BS EN55032(CISPR32) / BS EN/EN55011(CISPR11) CLASS A	I/P : 230 VAC (50HZ) O/P : FULL LOAD Ta : 25°C	PASS

4	E.S.D	EN61000-4-2 Level 3, 8KV air ; Level 2, 4KV contact	I/P : 230 VAC/50HZ O/P : FULL LOAD Ta : 25°C	CRITERIA A PASS
5	E.F.T	EN61000-4-4 Level 3	I/P : 230 VAC/50HZ O/P : FULL LOAD Ta : 25°C	PASS
6	SURGE	IEC61000-4-5 Level 4, 4KV/Line-Earth ; Level 3, 2KV Line- Line	I/P : 230 VAC/50HZ O/P : FULL LOAD Ta : 25°C	CRITERIA A PASS
7	Test by certified Lab & Test Report Prepare Any contradictions of the test results, please refer to the latest EMC test report			

■ RELIABILITY TEST

ENVIRONMENT TEST

NO	TEST ITEM	SPECIFICATION	TEST CONDITION	RESULT																																																				
1	TEMPERATURE RISE TEST	MODEL : RST-7K5-230 1. ROOM AMBIENT BURN-IN : 1 HRS I/P : 230VAC (Δ) O/P : FULL LOAD Ta= 25 °C 2. HIGH AMBIENT BURN-IN : 1 HRS I/P : 230VAC (Δ) O/P : FULL LOAD Ta= 45 °C																																																						
				<table border="1"> <thead> <tr> <th>NO</th> <th>Position</th> <th>ROOM AMBIENT Ta= 25 °C</th> <th>HIGH AMBIENT Ta= 45 °C</th> </tr> </thead> <tbody> <tr> <td>1</td> <td>A-board-Q151</td> <td>81.6°C</td> <td>102.6°C</td> </tr> <tr> <td>2</td> <td>A-board-D153</td> <td>72.7°C</td> <td>96.5°C</td> </tr> <tr> <td>3</td> <td>A-board-Q201</td> <td>77.1°C</td> <td>95.9°C</td> </tr> <tr> <td>4</td> <td>A-board-D203</td> <td>68.3°C</td> <td>91.0°C</td> </tr> <tr> <td>5</td> <td>A-board-BD100</td> <td>50.2°C</td> <td>72.4°C</td> </tr> <tr> <td>6</td> <td>A-board-BD151</td> <td>57.0°C</td> <td>79.6°C</td> </tr> <tr> <td>7</td> <td>A-board-L101</td> <td>40.3°C</td> <td>65.0°C</td> </tr> <tr> <td>8</td> <td>A-board-L151</td> <td>39.6°C</td> <td>62.9°C</td> </tr> <tr> <td>9</td> <td>D-board-Q333</td> <td>57.1°C</td> <td>80.4°C</td> </tr> <tr> <td>10</td> <td>D-board-Q383</td> <td>58.3°C</td> <td>82.3°C</td> </tr> <tr> <td>11</td> <td>D-board-Q384</td> <td>54.2°C</td> <td>77.7°C</td> </tr> <tr> <td>12</td> <td>D-board-Q432</td> <td>48.2°C</td> <td>72.3°C</td> </tr> </tbody> </table>	NO	Position	ROOM AMBIENT Ta= 25 °C	HIGH AMBIENT Ta= 45 °C	1	A-board-Q151	81.6°C	102.6°C	2	A-board-D153	72.7°C	96.5°C	3	A-board-Q201	77.1°C	95.9°C	4	A-board-D203	68.3°C	91.0°C	5	A-board-BD100	50.2°C	72.4°C	6	A-board-BD151	57.0°C	79.6°C	7	A-board-L101	40.3°C	65.0°C	8	A-board-L151	39.6°C	62.9°C	9	D-board-Q333	57.1°C	80.4°C	10	D-board-Q383	58.3°C	82.3°C	11	D-board-Q384	54.2°C	77.7°C	12	D-board-Q432	48.2°C	72.3°C
NO	Position	ROOM AMBIENT Ta= 25 °C	HIGH AMBIENT Ta= 45 °C																																																					
1	A-board-Q151	81.6°C	102.6°C																																																					
2	A-board-D153	72.7°C	96.5°C																																																					
3	A-board-Q201	77.1°C	95.9°C																																																					
4	A-board-D203	68.3°C	91.0°C																																																					
5	A-board-BD100	50.2°C	72.4°C																																																					
6	A-board-BD151	57.0°C	79.6°C																																																					
7	A-board-L101	40.3°C	65.0°C																																																					
8	A-board-L151	39.6°C	62.9°C																																																					
9	D-board-Q333	57.1°C	80.4°C																																																					
10	D-board-Q383	58.3°C	82.3°C																																																					
11	D-board-Q384	54.2°C	77.7°C																																																					
12	D-board-Q432	48.2°C	72.3°C																																																					

			13	D-board-T391	50.5°C	71.1°C
			14	D-board-U401	53.8°C	76.5°C
			15	E-board-LF2	64.6°C	89.6°C
			16	F-board-RG61	29.7°C	54.7°C
			17	F-board-T602	36.0°C	59.3°C
			18	F-board-U651	43.0°C	69.2°C
			19	F-board-U601	60.8°C	81.3°C
			20	F-board-T601	37.5°C	61.5°C
			21	F-board-Q671	36.0°C	56.2°C
			22	F-board-Q621	48.2°C	69.3°C
			23	F-board-D641	46.5°C	57.4°C
			24	F-board-D601	33.6°C	55.8°C
			25	G-board-C303	41.4°C	63.3°C
			26	G-board-D302	43.3°C	63.7°C
			27	G-board-T300	35.3°C	59.1°C
			28	G-board-L301	58.4°C	81.7°C
			29	G-board-C302	37.5°C	60.2°C
			30	H-board-C714	24.8°C	48.5°C
			31	H-board-R712	41.4°C	63.8°C
			32	H-board-L701	60.2°C	79.8°C
			33	H-board-T702	54.1°C	78.2°C
			34	I-board-RI11	43.7°C	68.6°C
			35	I-board-D713	52.4°C	77.1°C
			36	I-board-RJ11	37.9°C	62.2°C
			37	I-board-D714	53.4°C	76.7°C
			38	L-board-RY101	40.6°C	63.3°C
			39	TSW_1	44.2°C	70.0°C
			40	TSW_2	44.6°C	68.3°C
			41	TSW_3	30.9°C	55.5°C
			42	RTH9	25.9°C	51.9°C
2	OVER LOAD BURN-IN TEST	NO DAMAGE 1 HOUR (MIN)	I/P : 230 VAC(Δ) O/P : 104% LOAD Ta : 25°C		TEST : OK	
3	LOW TEMPERATURE TURN ON TEST	TURN ON AFTER 2 HOUR	I/P : 305VAC/230VAC(Δ) O/P : 100%/LOAD Ta= -35 °C		TEST : OK	
4	HIGH HUMIDITY HIGH TEMPERATURE HIGH VOLTAGE TURN ON TEST	AFTER 12 HOURS IN CHAMBER ON CONTROL 45 °C/95 %R.H NO DAMAGE	I/P : 230 VAC(Δ) O/P : FULL LOAD Ta= 45 °C HUMIDITY= 95 %R.H		TEST : OK	
5	TEMPERATURE COEFFICIENT	\pm 0.03 %/°C(0~45°C)	I/P : 230 VAC(Δ) O/P : FULL LOAD		\pm 0.003 %/°C(0~45°C)	



6	STORAGE TEMPERATURE TEST	-40~85°C	1. Thermal shock Temperature : -45°C~ +90°C 2. Temperature change rate : 25°C / MIN 3. Dwell time low and high temperature : 30 MIN/EACH 4. Total test cycle : 10 CYCLE 5. Input/Output condition : STATIC
7	THERMAL SHOCK TEST	-30~45°C	1. Thermal shock Temperature : -35°C~ +50°C 2. Temperature change rate : 25°C / MIN 3. Dwell time low and high temperature : 30 MIN/EACH 4. Total test cycle : 16 CYCLE 5. Input/Output condition : 15cycle:230V/ FULL LOAD AC ON 3sec/AC OFF 1sec TEST 1cycle:230V/ FULL LOAD Burn In Test
8	VIBRATION TEST	10 ~ 500Hz, 2G 10min./1cycle, 60min. each along X, Y, Z axes	1 Carton & 1 Set (1) Waveform : Sine Wave (2) Frequency : 10~500Hz (3) Sweep Time : 10min/sweep cycle (4) Acceleration : 3G (5) Test Time : 180min in each axis (X.Y.Z) (6) Ta : 25°C
9	CAPACITOR LIFE CYCLE	SUPPOSE C714 IS THE MOST CRITICAL COMPONENT (1) I/P : 230VAC O/P : FULL LOAD Ta= 25 °C LIFE TIME (2) I/P : 230VAC O/P : FULL LOAD Ta= 45 °C LIFE TIME (3) I/P : 230VAC O/P : 75% LOAD Ta= 45 °C LIFE TIME (4) I/P : 230VAC O/P : 50% LOAD Ta= 45 °C LIFE TIME	(1) 3829928HRS (2) 899576HRS (3) 921222HRS (4) 1010235HRS
10	MTBF	Conducted by Parts Stress Analysis Prediction 234.5K hrs min. Telcordia SR-332 (Bellcore) ; 27.1K hrs min. MIL-HDBK-217F (25°C)	
11	Ongoing Reliability Test	I/P : 230VAC O/P : FULL LOAD TA=50°C Demonstration Mean Time Between Failure : 50,000 hours	

TEST RESULT	TESTER	REVIEW	APPROVAL
PASS	DANIEL GAO	SANFORD SU	VINCENT TSENG

2020.10.1 TAG-QA-009